

**LD10238** with new E1 LED Light Engine

High Power Surface Mounted Adjustable Interior/Exterior LED Spotlight

Data sheet - Page 1



Design: Into Lighting Design  
Project: German Gymnasium, London  
Product: LD10238

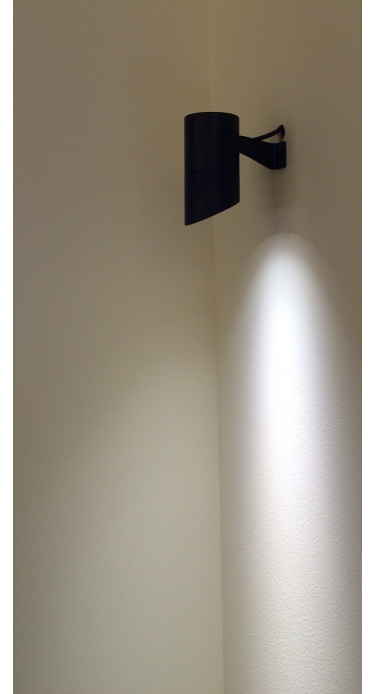

The new LD10238 features the all new E1 White LED engine, along with a new range of optics. Tunable White and RGBW options have also been added to the range. A compact, high power spotlight, with excellent output suitable for use in the harshest of external conditions. The LD10238 has a very minimal design ensuring it will blend into most interior and exterior project styles. The use of a single optic ensures excellent beam shape and soft edge. It comes with a wide range of fixing options and accessories and is available in a choice of finishes.

**Key Features**

- New E1 engine, featuring the CREE XHP35 LED with 2-step binning
- New optional 2nd channel LEDs for secondary lighting applications
- New optics, featuring an impressively narrow 10° spot is for lighting columns and arches, or a 15°x 49° spreader lens ideal for wall washing
- Low glare is achieved with a cowl, as well as recessing the LED and lens assembly deep within the body
- Optional glare louvre available
- Lockable tilt adjustment
- High quality machined components
- Single optic produces a very consistent beam with no multiple shadows
- Wide range of fixing options
- Range of finish options
- Built-in reverse polarity protection
- LD10238 is available with RGBW and Tunable White LED engines
- Available with Switch, 0-10V, DMX, Dali or Mains dimmable drivers

**Specification for E1 LED Engine**

## Applications



## Beam Angles

10°, 19°, 34°, 54°, 15°x 49°

## LED type

1 x E1 LED Engine with 2-step binning (LED data below)

## Colour temperature

2700K\*\* / 3000K / 4000K | 5000K

## Current

350mA | 500mA | 700mA | 350mA | 500mA | 700mA

## LED power (Max)

5W (4.4W)*	7W (6.3W)*	10W (9W)*	5W (4.4W)*	7W (6.4W)*	10W (9W)*
---------------	---------------	--------------	---------------	---------------	--------------

## CRI (Min)

85 | 85 | 85 | 80 | 80 | 80

Forward voltage (V)<sub>100</sub>

14V | 14V | 14V | 14V | 14V | 14V

Delivered lumens (L<sub>100</sub>)

358 | 474 | 566 | 386 | 511 | 611

## Lumens per circuit watt

71 | 68 | 56 | 77 | 73 | 61

## LED lifetime (to 70% lumen maintenance)

50,000hrs at a max ambient temperature of 35°C (if higher ambient then run at 500mA up to 45°C)

## Glass

3mm thick low iron glass

## Materials

Anodised aluminium body, with stainless steel fixing bracket

## Wiring

Comes pre-wired with 1m lead. Single colour equipped with 2 core cable, 2 Channel or TW engine with 4 core cable &amp; RGBW with 8 core cable. Can be specified with up to 10m at extra cost.

## IP rating

IP67

\*indicates the nominal power for the LED run at that particular current and includes losses associated with using an 85% efficient driver

\*\*2700K lumen output is 8% lower than the 3000K figure listed

# LD10238 with new E1 LED Light Engine



High Power Surface Mounted Adjustable Interior/Exterior LED Spotlight

Data sheet - Page 2

## Fixing options and dimensions

**/SAM** Surface adjustable mounting is screwed to the mounting surface and allows for minor rotational adjustment. The tilt adjustment is lockable via the socket head screw on the side.

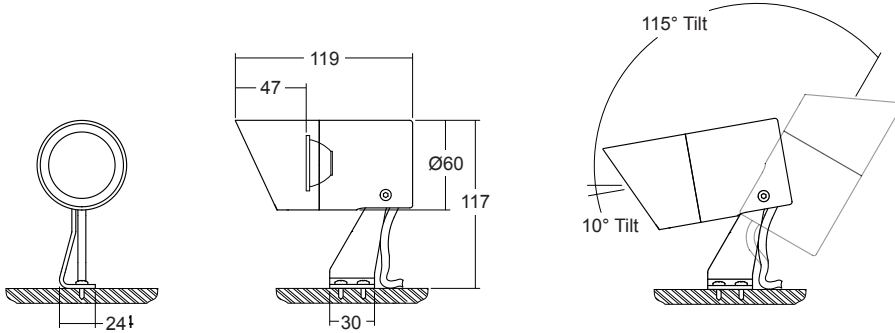

**/SMB** Surface mount base offers hidden wiring and a machined pivot arm with lockable tilt and rotation.

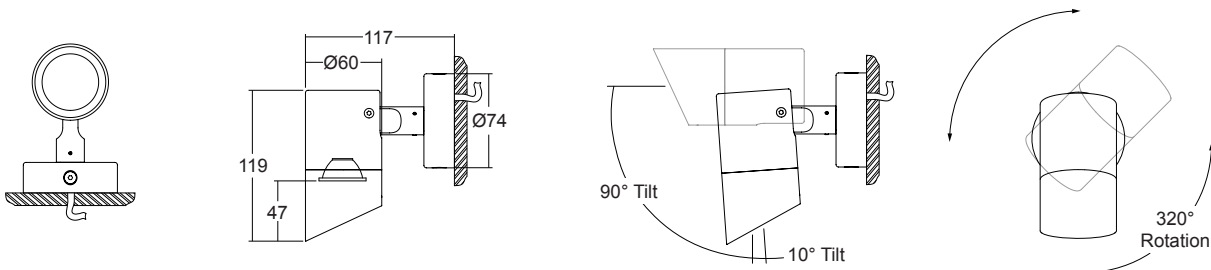

# LD10238 with new E1 LED Light Engine



High Power Surface Mounted Adjustable Interior/Exterior LED Spotlight

Data sheet - Page 3

**/GSA** Adjustable ground spike with lockable tilt adjustment, for in ground applications. It also has a height adjustment of 490mm to 695mm to the centre of the fitting.

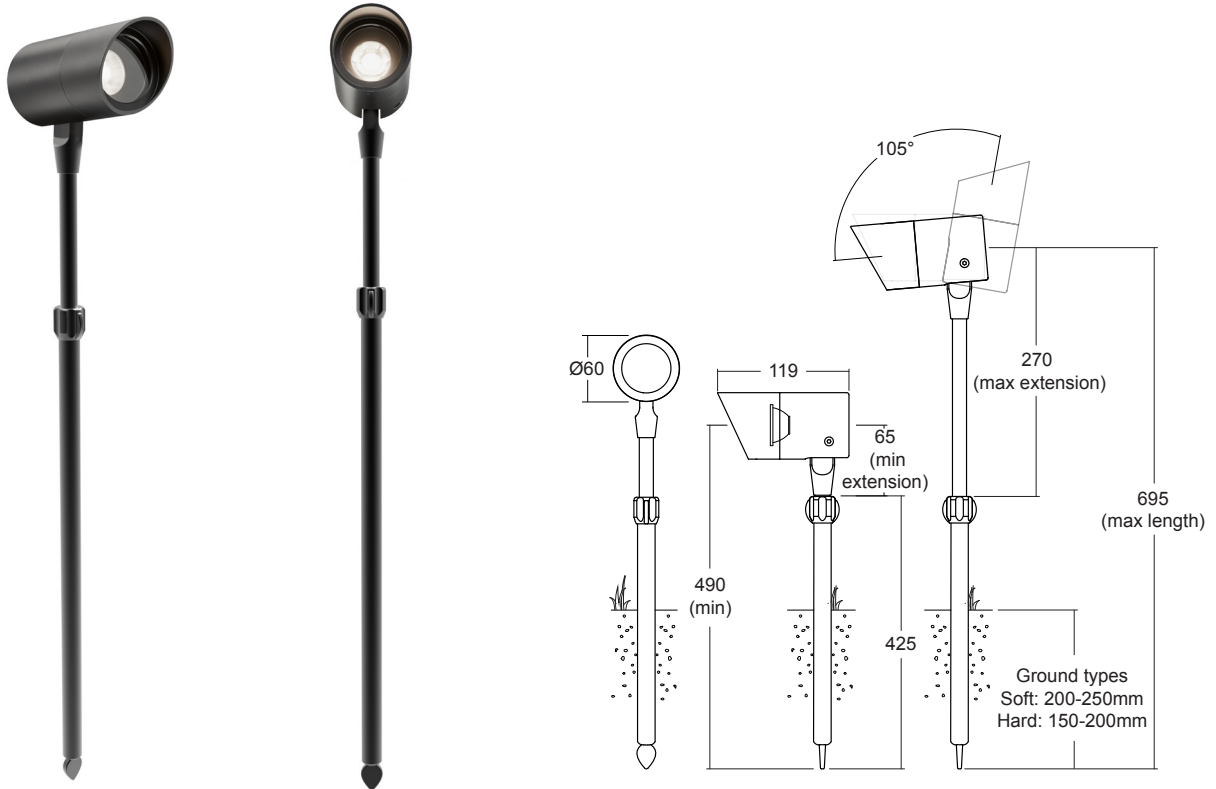

**/SMBEX** Surface mount base with lockable tilt adjustment has a customisable arm length. It can be specified between 130mm and 600mm to the centre of the fitting. Suitable for vertical and horizontal mounting.

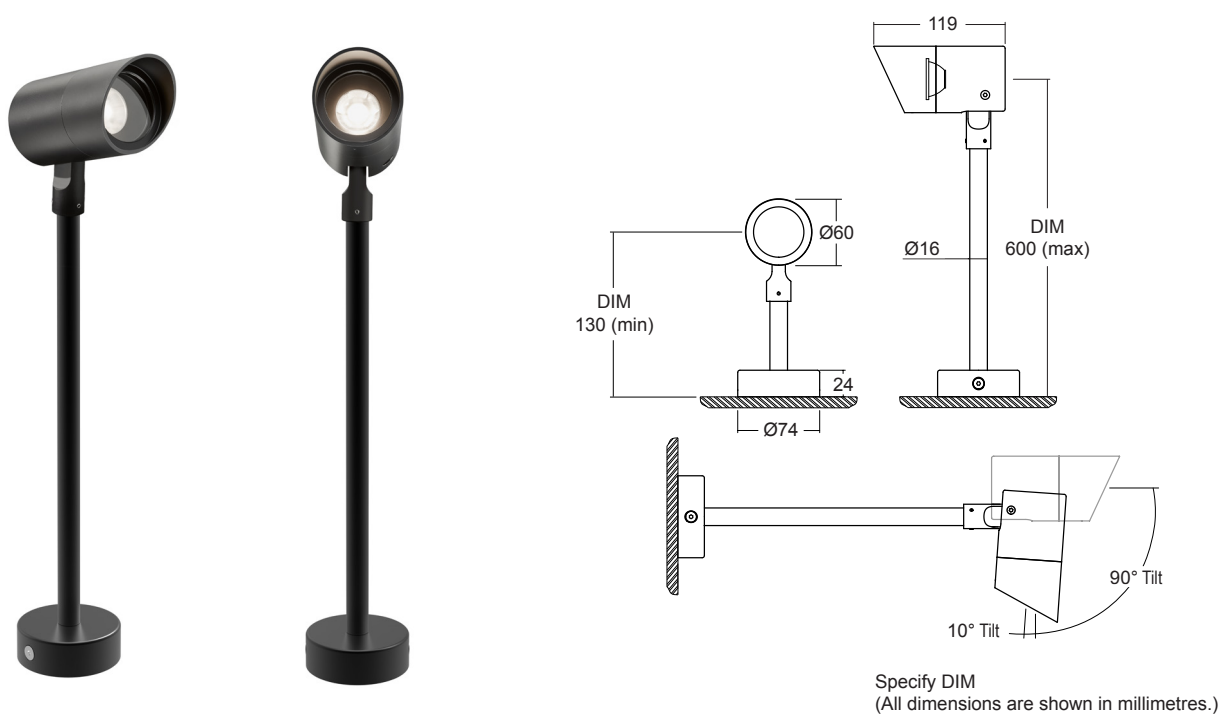

**LD10238** with new E1 LED Light Engine



High Power Surface Mounted Adjustable Interior/Exterior LED Spotlight

Data sheet - Page 4

**/GS** Ground spike for in ground applications. Lockable tilt adjustment.

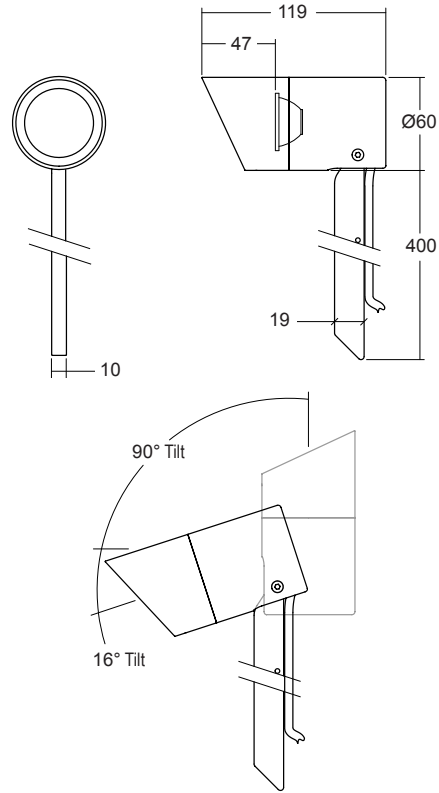

**/TS** Tree strap accessory is manufactured from a woven nylon webbing, covered with a recycled rubber coating which allows it to grip the trunk when tightened. It allows for minor rotational adjustment. A tilt adjustment of 10deg can be achieved towards the tree and is lockable via the socket head screw on the side.

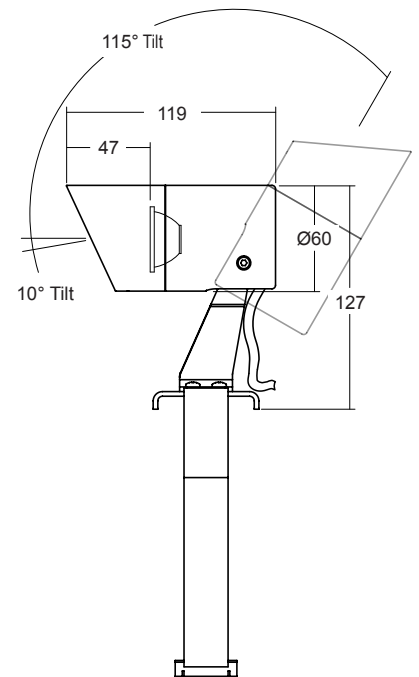
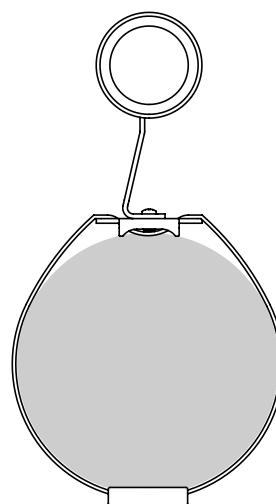

Trunk measurements:  
1400mm circumference  
Ø450 maximum diameter

# LD10238 with new E1 LED Light Engine



High Power Surface Mounted Adjustable Interior/Exterior LED Spotlight

Data sheet - Page 5

## Cone Diagrams

Cone diagrams below are based on a 3000K E1 LED engine run at maximum output 700mA, 10W. Images below, represent beam output when the fitting is pointed directly at the lit surface @ 2m, with the second image representing beam output when wall washing a 3m wall, spaced 125mm away from the lit surface.

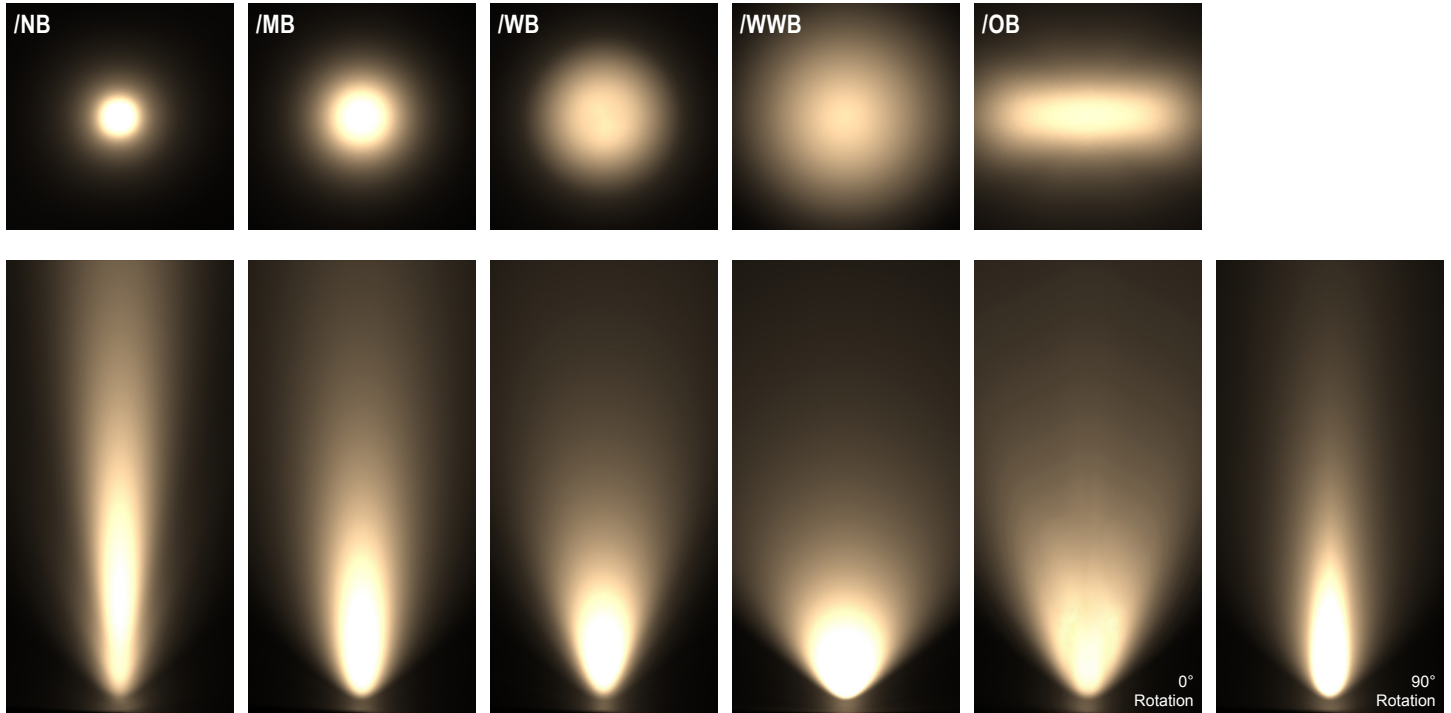

**Narrow Beam**  
700mA using a 10° optic

Distance (m)	Cone Width (m)	Luminance (lx)
3.0	0.62	750
2.5	0.52	1080
2.0	0.41	1688
1.5	0.31	3000
1.0	0.21	6751
0.5	0.10	27002

**Medium Beam**  
700mA using a 19° optic

Distance (m)	Cone Width (m)	Luminance (lx)
3.0	1.06	346
2.5	0.88	498
2.0	0.71	779
1.5	0.53	1384
1.0	0.35	3114
0.5	0.18	12456

**Wide Beam**  
700mA using a 34° optic

Distance (m)	Cone Width (m)	Luminance (lx)
3.0	1.97	114
2.5	1.64	164
2.0	1.32	256
1.5	0.99	455
1.0	0.66	1024
0.5	0.33	4095

**Extra Wide Beam**  
700mA using a 54° optic

Distance (m)	Cone Width (m)	Luminance (lx)
3.0	3.06	55
2.5	2.55	79
2.0	2.04	124
1.5	1.53	220
1.0	1.02	496
0.5	0.51	1984

**Oval Beam**  
700mA using a 15° X 49° optic

Distance (m)	Cone Width (m)	Luminance (lx)
3.0	2.70 / 0.74	190
2.5	2.25 / 0.61	274
2.0	1.80 / 0.49	428
1.5	1.35 / 0.37	761
1.0	0.90 / 0.25	1712
0.5	0.45 / 0.12	6846

Photometric files (LDT) are included in the design pack which can be downloaded from the LD10238 E1 product page on the website.

## Accessory

**/HL** Honeycombe louvre for reduced glare. Please note this is not suitable for use with the 15° x 49° deg oval beam or RGBW optic due to the quality of the beam.

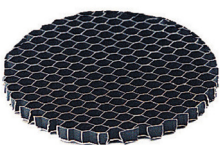

# LD10238 with new E1 LED Light Engine



High Power Surface Mounted Adjustable Interior/Exterior LED Spotlight

Data sheet - Page 6

## Product Features & Options

### BEZEL / COWL

Paint finish white (RAL 9016) / Black / Antique bronze / Satin Antique Brass / Silver Anodised. Other paint finishes available, please talk to sales.

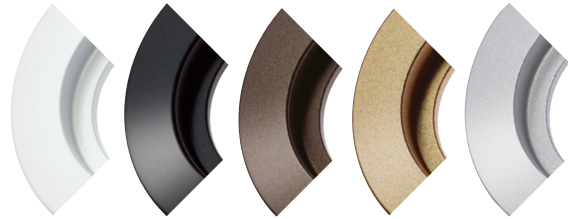

### HONEYCOMB LOUVRE

Optional accessory to further reduce glare coming from the aperture of the fitting.

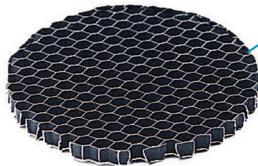

### OPTIC HOLDER

Matt black anodised for reduced glare.



### OPTIC

Revised high efficiency optics with a new range of beam angles to create the ideal lit effect.

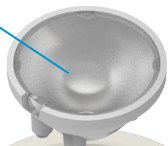

### BODY

Machined and anodised body. 6000 series aluminium chosen for its thermal characteristics and resistance to corrosion. Paint finish applied on top.



### LED

- E1 LED engine.
- E1 LED engine, with the optional 2nd channel.
- TW Tunable White LED engine.
- RGBW LED engine with colour mix lens.
- CLR Colour LED engine.

### FIXING OPTIONS



# LD10238 with new E1 LED Light Engine













High Power Surface Mounted Adjustable Interior/Exterior LED Spotlight

Data sheet - Page 7

## LED Options and Technology

### New LED Options

LD10238 is now available with a choice of light engines which feature a new all copper board for increased thermal transfer. The new E1 light engine for white light applications uses the new Cree XHP35 LED and features on board polarity protection.. This smaller LED chip has enabled a wider range of beam angles to be offered, coupled with increased efficiencies. This engine is also available with two extra LEDs on a second channel, for night lighting and marine navigation applications. The new tunable white engine offers a choice of dynamic colour options.

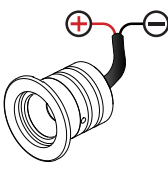
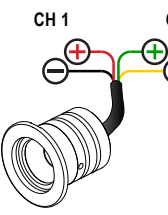
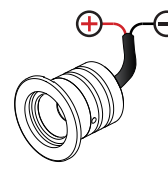
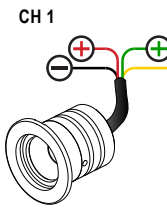
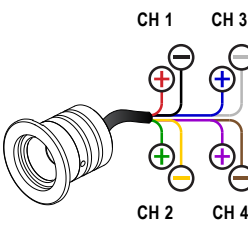
	<b>E1 Light Engine (White light)</b> 	<b>E1-2CH 2nd channel board</b> 	<b>CLR - Colour</b> 	<b>TW - Tunable White</b> 	<b>RGBW</b> 
LED Board					
LED type	Cree XHP35	Cree XHP35 + XQE's	Cree XQE's	Cree XQE's	Cree XML
Key Features	<ul style="list-style-type: none"> <li>- Available in 2700K, 3000K, 4000K and 5000K</li> <li>- Very small chip size</li> <li>- Tighter narrow beams</li> <li>- Wider range of beam angles</li> <li>- 2 step binning</li> <li>- Brighter more efficient LED</li> <li>- On board polarity protection</li> <li>- All copper LED board for increased thermal transfer</li> </ul>	<ul style="list-style-type: none"> <li>- Main white LED with optional 2nd channel for night lighting or marine navigation applications</li> <li>- 2nd channel comprises of 2 XQE LEDs mounted next to the XHP35</li> <li>- Beam shape from the XQE's is different from the main LED as they are mounted to the sides of the optic</li> <li>- 2 driver circuits required</li> <li>- All copper LED board</li> </ul>	<ul style="list-style-type: none"> <li>- 4 colour XQE LEDs mounted under a single optic</li> <li>- All copper LED board</li> <li>- Red, Blue, Green and Amber colour LED options</li> <li>- Single LED circuit</li> </ul>	<ul style="list-style-type: none"> <li>- 4 XQE LEDs mounted under a single optic</li> <li>- 2 LEDs per colour</li> <li>- Excellent dynamic white mixing from a range of optics</li> <li>- All copper LED board</li> <li>- 2 driver circuits required</li> </ul>	<ul style="list-style-type: none"> <li>- RGBW LEDs mounted under a single 26deg optic for superb colour mixing</li> <li>- White LED is 4000K</li> <li>- All copper LED board</li> <li>- 4 LED circuits required</li> </ul>
Cables					
Lumen output	See front page	See front page		See table below	

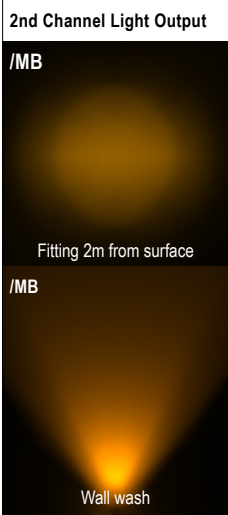

Colour temperature	Warm White 2700K or 3000K	Cool White 4000K or 5000K
Current	500mA	500mA
LED power (Max) All channels in use	7W (6.3W) 3.5W per channel	
CRI (Min)	85	
Delivered lumens (L <sub>100</sub> )	148lm	188lm
Lumens per circuit watt	42	54

### Industry Leading LED Thermal Management

High quality, embedded copper PCB, with direct contact cooling for the LEDs providing industry leading thermal management of the LED. Guaranteeing long life and minimal colour shift.



# LD10238

 with new E1 LED Light Engine

High Power Surface Mounted Adjustable Interior/Exterior LED Spotlight

Data sheet - Page 8

## Order Codes and Options

### White LED Options - E1 Light Engine



Product code	LED colour	Lens angle	Finish	Fixing method & accessory
LD10238-E1-350 - 500 - 700				

Example: LD10238-E1-700 / LW30 / NB / Black / SMB / HL

#### Product codes with output options

5W LED at 350mA	LD10238-E1-350
7W LED at 500mA	LD10238-E1-500
10W LED at 700mA	LD10238-E1-700

#### LED colour options

LED colour options	Suffix
Extra Warm White (2700K)	/LW27
Warm White (3000K)	/LW30
White (4000K) - on request	/LW40
Cool White (5000K)	/LW50
With 2nd channel (red for navigation or amber night lighting) LD10238-E1-2CH	/LW**+L*

For other single colour options, please discuss with the sales team

#### Beam / lens angle options

10° narrow spot	/NB
19° medium	/MB
34° wide	/WB
54° extra wide	/WWB
15° x 49° oval	/OB

#### Paint finish options

Silver / black / white (RAL 9016) / RAL finish  
(please see our finishes guide for bronze and other wet spray finishes)

#### Fixing methods and accessories

Surface arm mounting	/SAM
Surface mount base	/SMB
Adjustable ground spike	/GSA
Surface mount base with customisable extended arm (specify DIM)	/SMBEX (DIM)
Ground spike	/GS
Tree strap	/TS
Honeycomb louvre (not suitable for oval beam or RGBW)	/HL

#### Use with 350mA, 500mA & 700mA constant current LED drivers

We have a wide range of dimmable LED drivers, 0-10V, DMX, DALI and Mains dimmable. Please see the downloads section on our website:  
To run 1-4 LD10238-E1-350 in series use a TXDEL350D (0-10V dimmable)  
To run 1-4 LD10238-E1-500 in series use a TXDEL500D (0-10V dimmable)  
To run 1-4 LD10238-E1-700 in series use a TXDEL700D (0-10V dimmable)

### Colour LED Options - CLR Light Engine



Example: LD10238-CLR-500 / LR / MB / Black / SMB

#### LED colour options (max 500mA)

LED colour options (max 500mA)	Suffix
Red	/LR
Green	/LB
Blue	/LG
Amber	/LA

Driver requirements identical to E1 engine, beam angles identical to TW engine

### Tunable White Options - TW Light Engine



Product code	LED colour	Lens angle	Finish	Fixing method & accessory
LD10238-TW-350 - 500				

Example: LD10238-TW-500 / LW27 + LW40 / MB / Black / SMB

#### Product codes with output options

5W LED at 350mA - 2 channels of 2 x 1.2W	LD10238-TW-350
7W LED at 350mA - 2 channels of 2 x 1.7W	LD10238-TW-500

#### LED colour options

LED colour options	Suffix
Tunable White 2700K & 4000K (standard option)	/LW27 + LW40
Tunable White 2700K & 5000K	/LW27 + LW50
Custom	/LW** + LW**

Fitting comprised of 2x LEDs in one colour temperature & 2x LEDs in another.  
Other white colour options available on request, please discuss with our sales team.

#### Beam / lens angle options

Narrow spot not available due to poor colour mixing	
24° medium	/MB
38° wide	/WB
54° extra wide	/WWB
20° x 46° oval	/OB

#### Finish and fixing options

Same as White LED options using the E1 Light Engine

#### Use with 350mA & 500mA constant current LED drivers

We have a wide range of dimmable LED drivers, 0-10V, DMX, DALI and Mains dimmable. Please see the downloads section on our website:  
To run 1-7 LD10238-TW-350 in series use 2x TXDEL350D (0-10V dimmable)  
To run 1-7 LD10238-TW-500 in series use 2x TXDEL500D (0-10V dimmable)

### Colour Change RGBW Options - RGBW Light Engine



Product code	Finish	Fixing method & accessory
LD10238-RGBW-350 - 500		

Example: LD10238-RGBW-500 / Black / SMB

#### Product codes with output options

5W LED at 350mA (4x 1.2W LEDs)	LD10238-RGBW-350
7W LED at 500mA (4x 1.7W LEDs)	LD10238-RGBW-500

RGBW features a 4000K white LED for creating hues

#### Beam / lens angle

38° colour mix lens

#### Finish and fixing options

Same as White LED options using the E1 Light Engine

#### Use with 350mA & 500mA constant current LED drivers

We have a range of dimmable LED drivers DMX and DALI compatible. Please see the downloads section on our website:  
To run 2-13 LD10238-RGBW-350 in series use a TXDEL4A350DMX or TXDEL4A350DALI  
To run 2-13 LD10238-RGBW-500 in series use a TXDEL4A500DMX or TXDEL4A500DALI